

Maxi Marine - MM/MME/MMC/MMCE

120-15 000 l.

EN



SAFETY INFORMATION
O&M INFORMATION
INSTALLATION MANUAL

Manufactured by OSO Hotwater AS
Industriveien 1 - 3300 Hokksund - Norway
Tel: + 47 32 25 00 00 / E-mail: oso@oso.no
www.osohotwater.com

11002273-06 - 04-2024

OSO
HOT WATER

CONTENTS

1. Safety instructions	3
1.1 General information	3
1.2 Safety instructions for users.....	4
1.3 Safety instructions for installers	4
2. Product description	5
2.1. Product identification	5
2.2. Intended use.....	5
2.3 CE marking	5
2.4 Technical data.....	5
3. Instructions for installation, operation and maintenance	6
3.1. Products covered by these instructions.....	6
3.2. Specs and installation.....	6
4. Delivery, location and installation	7
4.1 Delivery.....	7
4.2 Requirements for installation, location and positioning.....	7
4.3 Pipe installation.....	8
4.4 General note	8
4.5 Installation, operation and maintenance.....	8
4.6 Electrical installation	10
4.7 Wiring diagrams, schematic.....	11
4.8 K12 terminal box - optional.....	14
5. Initial commissioning	16
5.1 Filling with water	16
5.2 Turning on the power	16
5.3 Control points.....	16
5.4 Emptying of water.....	16
5.5 Handover to end-user.....	16
6. User guide	17
6.1 Settings.....	17
6.2 Annual inspection.....	17
6.3 Maintenance.....	17
Contact details - installer	18
7. Warranty conditions	19
7.1. Customer service.....	19
8. Removing the product	19
8.1. Removal	19
8.2. Returns scheme	19



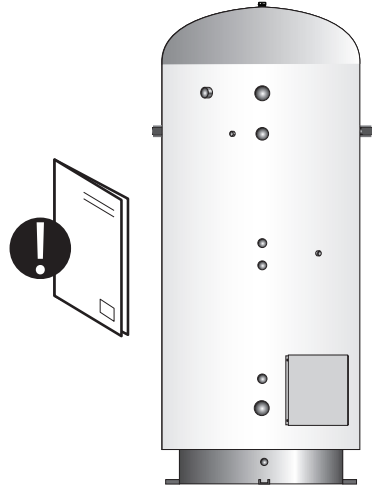

1. SAFETY INSTRUCTIONS

1.1 General information





- Read the following safety instructions carefully before installing, maintaining or adjusting the buffer tank.
- Personal injury or material damage may result if the product is not installed or used in the intended manner.
- Keep this manual and other relevant documents where they are accessible for future reference.
- The manufacturer assumes compliance (by the end-user) with the safety, operating and maintenance instructions supplied and (by the installer) with the fitting manual and relevant standards and regulations in effect at the date of installation.
- Ensure installation is in compliance with the applicable class rules.





Symbols used in this manual:





 WARNING	Could cause serious injury or death
 CAUTION	Could cause minor or moderate injury or damage to property
 DO NOT	
 DO	





1.2 Safety instructions for users

 WARNING	
	The overflow from any safety valve shall NOT be sealed or plugged.
	The product must NOT be modified or changed from its original state.
	Children must NOT play with the product or go near it without supervision.
	Maintenance/settings shall only be carried out by persons over 18 years of age, with sufficient understanding

 CAUTION	
	The product must not be exposed to frost, over-pressure, over-voltage or chlorine treatment. See warranty provisions.
	Maintenance/settings shall not be carried out by persons of diminished physical or mental capacity, unless they have been instructed in the correct use by someone responsible for their safety.

1.3 Safety instructions for installers

 WARNING	
	The overflow from any safety valve shall NOT be sealed or plugged.
	Any discharge pipe from the safety valve MUST be ≥ 18 mm inside, fitted uninterruptable, undamaged and frost-free with a fall to a suitable drain or gully.
	The relevant regulations and standards, and this installation manual, must be followed.

 CAUTION	
	The product shall be placed in a room with a drain. Alternatively, fit an automatic stop valve with sensor and a discharge pipe from the safety valve overflow to a suitable drain or gully. Liability for consequential damage will only apply if this is followed.
	The product shall be properly aligned vertically and horizontally, on a floor suitable for the total weight of the product when in operation. See type plate.
	The product must have a clearance for servicing of 40 cm in front of the electric junction box cover / 10 cm. above the highest point.

2. PRODUCT DESCRIPTION

2.1 Product identification

Identification details for your product can be found on the type plate fixed to the product. The type plate contains technical details of the product. See Declaration of Conformity at www.osohotwater.com for more information.

OSO products can be designed and manufactured to order, in accordance with customer choice of certification:

- Pressurized equipment PED 2014/68/EU
- Safety standard EN 60335-2-21

OSO Hotwater is certified for

- Quality ISO 9001
- Environment ISO 14001
- Work environment ISO 45001
- Welding quality ISO 3834-2

2.2 Intended use

The Maxi Marine series is designed for supplying domestic hot water in ships and offshore installations. The Maxi Marine series can be customer specified with or without electric elements, with or without a built-in heat exchanger coil, or with any combination of the above.

2.3 CE marking



The CE mark shows that the product complies with the relevant Directives. See Declaration of Conformity at www.osohotwater.com for more information.

The product complies with EU Directives for:

- Low voltage LVD 2014/35/EU
- Electromagnetic compatibility EMC2014/30/EU
- Pressurized equipment PED 2014/68/EU

The safety valve(s) used must be CE marked and conform to PED 2014/68/EU.

2.4 Technical data (standard products)

Prod. No.	Product code:	IP class	Capacity persons	Weight kg.	Dia x height mm.	Freight vol. m ³	Actual volume L
11003420	Maxi Marine 120	IP21	Calculate	38	Ø580x760	0.34	112
11003421	Maxi Marine 200	IP21	Calculate	52	Ø580x1190	0.54	195
11003422	Maxi Marine 300	IP21	Calculate	68	Ø580x1640	0.71	282
11003423	Maxi Marine 400	IP21	Calculate	84	Ø580x2130	0.87	376
11003424	Maxi Marine 600	IP21	Calculate	114	Ø780x1900	3.39	537
11003425	Maxi Marine 750	IP21	Calculate	168	Ø980x1820	3.39	759
11003426	Maxi Marine 1000	IP21	Calculate	185	Ø980x2070	3.39	883
11003429	Maxi Marine 1500	IP21	Product data subject to customer specifications				
11003427	Maxi Marine 2000	IP21	Product data subject to customer specifications				
11003428	Maxi Marine 3000	IP21	Product data subject to customer specifications				

Regulation: 2017/1369/EU - Regulation: EU 812/2013

Directive: 2009/125/EC - Regulation: EU 814/2013

Volumes up to 15 000 l. can be made to order.

Standard products are shown in table.

The Maxi Marine series can be designed to customer specifications. All information in table is subject to change when product is designed to customer specifications.

MANUFACTURER NOTIFICATION

The product shown in this manual is equipped with both electric immersion heaters and a heating coil as well as a standard nozzle layout. The products can however be designed entirely to customer specifications and the product that is supplied with this manual may be specified with a different layout than the illustrations in the manual.

3. INSTRUCTIONS FOR INSTALLATION, OPERATION AND MAINTENANCE

3.1 Products covered by these instructions

Maxi Marine Buffer tank - MM 120-5000
Maxi Marine Coil - MMC 120-5000
Maxi Marine Electric - MME 120-5000
Maxi Marine Coil + Electric - MMCE 120-5000

3.2 Specs and installation

The OSO Maxi Marine series is manufactured to customer specifications. Pipe connections and general design layout, including electric central(s) and heating coil(s), are specified individually for each product in collaboration between the customer and OSO.

This manual shows the basic standard layout of the Maxi Marine series products. Additional features and fixtures (including electrical components and circuit diagrams) will be described in separate documents supplied with the product.

Installation of the product must be in accordance with relevant current standards and regulations as well as this manual. See also pt. 4.2.

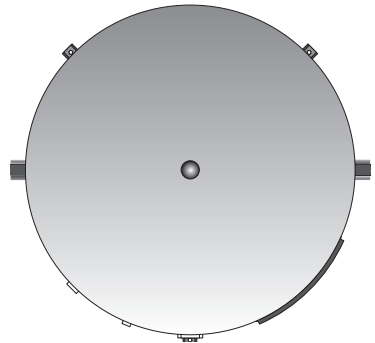
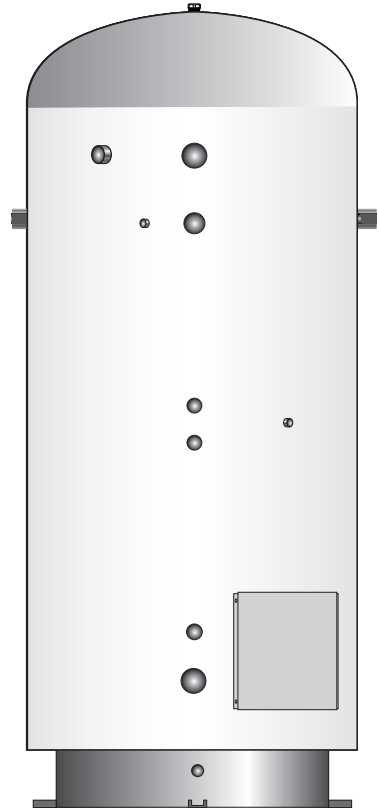

4. DELIVERY, LOCATION AND INSTALLATION

4.1 Delivery

The product should be transported carefully to its designated location, with packaging.

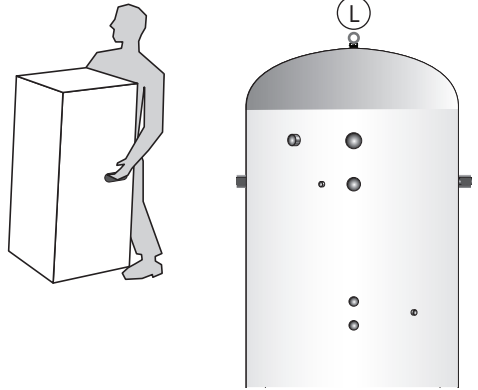

CAUTION
<p>Pipe stubs, valves etc. should not be used to lift the product as this could cause malfunctions. Products larger than 400 l. are fitted with a lifting lug (L), see illustration. Specific lifting instructions are supplied with the product.</p>

4.2 Requirements for installation, location and positioning

CAUTION	
	<p>The product shall be placed in a room with a drain. Alternatively, fit an automatic stop valve with sensor and a discharge pipe from the safety valve overflow to a suitable drain or gully. Liability for consequential damage will only apply if this is followed.</p>
	<p>The product shall be placed in a dry and permanently frost-free position.</p>
	<p>The product shall be placed on a floor suitable for the total weight of the product when in operation. See type plate.</p>
	<p>The product must have a clearance for servicing of 40 cm in front of the electric junction box cover (1) and 10 cm. above the highest point.</p>
	<p>The product shall be easily accessible for servicing and maintenance.</p>

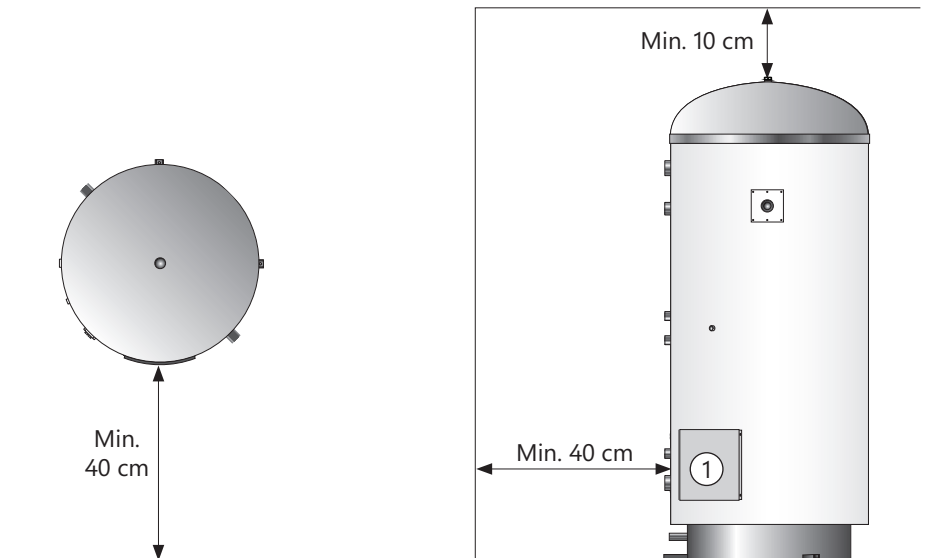

4.3 Pipe installation

4.3.1 Nozzles

No.	Dimension	Connection description
1	1" internal thread	Lifting lug
2	1 1/2" internal thread	Potable hot water outlet
3	1" internal thread	P&T safety valve
4	1/2" internal thread	Thermometer
5	1 1/2" internal thread	Hot water circulation - HWC
6	1" internal thread	Sensor (units with coil only)
7	3/4" internal thread	Anode
8	1" internal thread	Coil connection FLOW
9	1" internal thread	Coil connection RETURN
10	1 1/2" internal thread	Potable cold water inlet
11	1" external thread	Drain connection

4.4 General note

Refer to illustration (right) which is typical for standard units. Pipe connections and valves, see illustration below.

4.5 Installation, operation and maintenance

The product is factory fitted with wall and floor mounting brackets (A) and (B). These brackets must be used to ensure safe operation.

The product is also factory fitted with a lifting lug (L). A separate instruction leaflet regarding safe lifting and handling of the product is supplied with the product.

4.5.1 Filling the vessel

Connect flow and return and all necessary pipes, using a suitable sealant. Unused nozzles must be plugged. Stop valves can be added to flow and return pipes, see illustration (not supplied).

To fill vessel, open the cold water supply. Vent vessel through an outlet/valve positioned directly after the vessel hot water outlet, situated higher than the top of the vessel. Alternatively a higher positioned hot water tap can be used. When vessel is full (water flows evenly at the outlet) close venting outlet.

When the system is pressurised, check all pipe connections for leaks. Tighten if necessary. All connections should be re-checked after approx. 3 months of service, then annually.

4.5.2 Operation

During operation ensure that all valves are in position as in illustration:

NO = NORMALLY OPEN DURING OPERATION
NC = NORMALLY CLOSED DURING OPERATION.

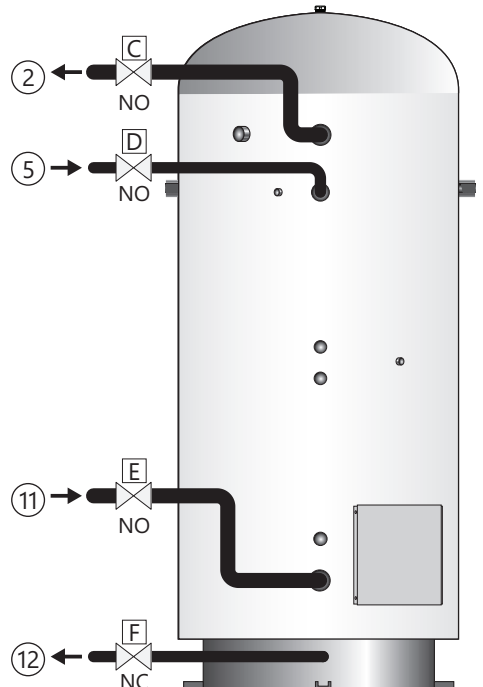
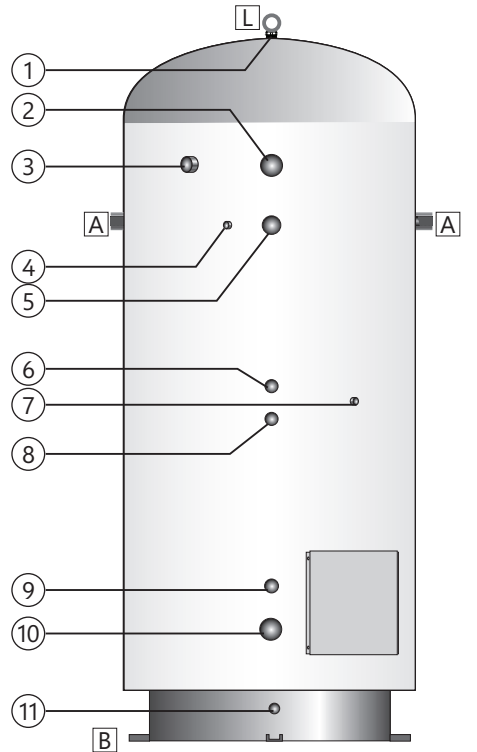

4.5.3 Maintenance (also see pt. 5.2)

Cleaning the pressure vessel:

Open the cold potable water flow fully for approx. 1 hour.

It is recommended to check all pipe connections for leaks after approx. 3 months service and then annually to avoid unwanted water spillage, with possible damage to the vessel or its surroundings.

4.5.4 Important

Follow the instructions for use and operation. The vessel is designed for a max. operating pressure of 10 bar. Test pressure is 15 bar.

4.5.5 Draining the vessel

- Turn off power supply.
- Turn off cold water supply - close valve (E) if fitted (not supplied).
- Open a hot water tap to avoid vacuum locking and aid draining speed.
- Drain vessel through drain connection (12), open valve (F) if fitted (not supplied).

4.5.6 Troubleshooting

Always disconnect power supply before opening the electric junction box.

⚠ WARNING

Constant voltage is present at the terminals. Before any electrical work is done, the power supply must be disconnected and secured against activation while the work is in progress.

Not enough hot water:

- Check system for hot water leaks
- Turn up thermostats (see 5.1)
- Check temperature control valve

Cold water only:

- Press reset button on thermostats (see 5.1.2).
- Turn thermostats down approx. 5°C
- Check fuses

If problem still persists the thermostats or elements may need replacing. Contact installer.

If water spillage is discovered around water heater base, check all pipe fittings and tighten if necessary. Check for leaks at elements inside electric junction box. If a leak is found, tighten element or replace the o-ring seal.

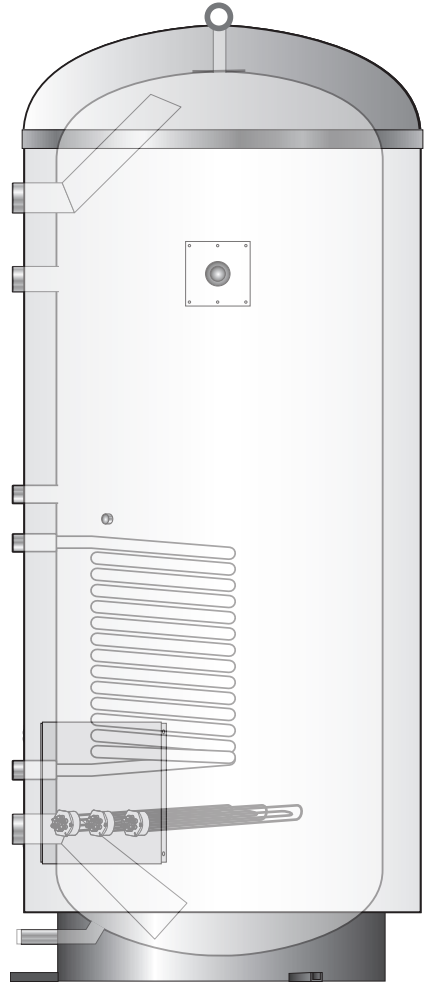

MANUFACTURER NOTIFICATION

The product shown in this manual is equipped with both electric immersion heaters and a heating coil as well as a standard nozzle layout. The product can however be designed entirely to customer specifications and the product that is supplied with this manual may be specified with a different layout than the illustrations in the manual.

4.6 Electrical installation

Fixed electrical fittings must be used for installation. Any electrical fittings must be installed by an authorised electrician. The relevant standards and regulations must be followed.

4.6.1 Electrical components - if fitted (options available on customer request)

Component	Note
1 Safety thermostat	98°C thermal cut-out
2 Work thermostat	Adjustable 40-70 or 60-90°C
3 Internal wires	According to spec.
4 Heating element	3-phase 230-480 V

4.6.2 Electrical connections in the junction box

Note: The description on next page is for a standard junction box. The product can be fitted with customer spec junction box(es) with other connection requirements. Check separate documents if supplied.

- A) Supply cable is connected to terminal (5) as shown. Supply wires shall be secured with suitable strain relievers.
- B) Internal wires from connection piece (5) to thermostats and the wires from thermostats to elements are pre-connected from the factory.
- C) Make sure that the earth wire (yellow wire with green stripe) is connected to the earthing point ⏚ on the vessel.

Electric junction box cover shall be correctly refitted before the power is switched on. The power must not be switched on until the product has been filled with water.

4.6.3 Torque settings - std. junction box

Component	Torque
G 1.1/4" - 1.1/2" heating element	60 Nm (+/- 5)
Thermostat screws	2 Nm (+/- 0.1)
Screw on the element head	2 Nm (+/- 0.1)

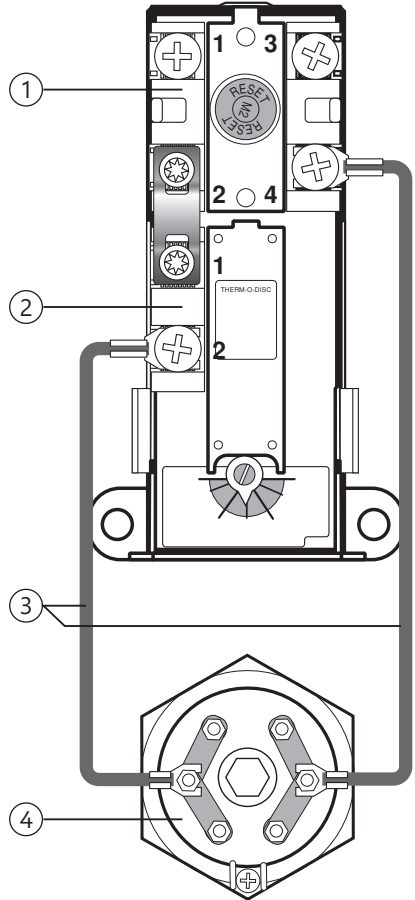

4.7 Wiring diagrams, schematic

OSO Maxi Marine products can be fitted with customer specified electrical layout. The shown schematics are standard layouts, see electrical specifications for your product for the correct layout.

4.7.1 Wiring diagram

Junction box with 3 elements. Max. voltage 480V. Possible power output variations:

Power input	Power output
3x230V	4.05 kW (3x1.35 kW)
3x380V	11.1 kW (3x3.7 kW)
3x400V	12.3 kW (3x4.1 kW)
3x415V	13.2 kW (3x4.4 kW)
3x440V	15 kW (3x5 kW)
3x460V	16.5 kW (3x5.5 kW)
3x480V	17.6 kW (3x5.9 kW)

 WARNING

Constant voltage is present at the terminals. Before any electrical work is done, the power supply must be disconnected and secured against activation while the work is in progress.

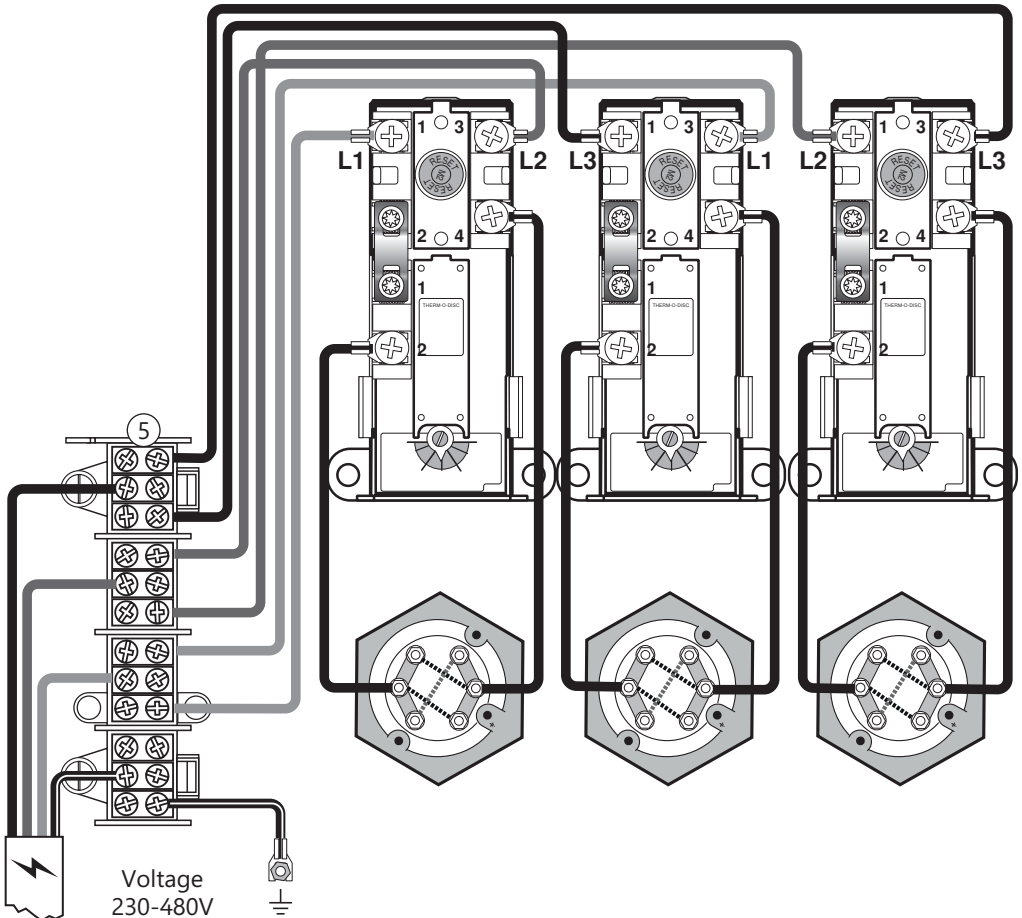

4.7.2 Wiring diagram

Junction box with 6 elements. Max. voltage 480V. Supply cable is connected to terminal (5) as shown. Supply wires shall be secured with suitable strain relievers.

Possible power output variations:

Power input	Power output
3x230V	8.1 kW (6x1.35 kW)
3x380V	22.2 kW (6x3.7 kW)
3x400V	24.6 kW (6x4.1 kW)
3x415V	26.4 kW (6x4.4 kW)
3x440V	30 kW (6x5 kW)
3x460V	33 kW (6x5.5 kW)
3x480V	35.4 kW (6x5.9 kW)

⚠ WARNING

Constant voltage is present at the terminals. Before any electrical work is done, the power supply must be disconnected and secured against activation while the work is in progress.

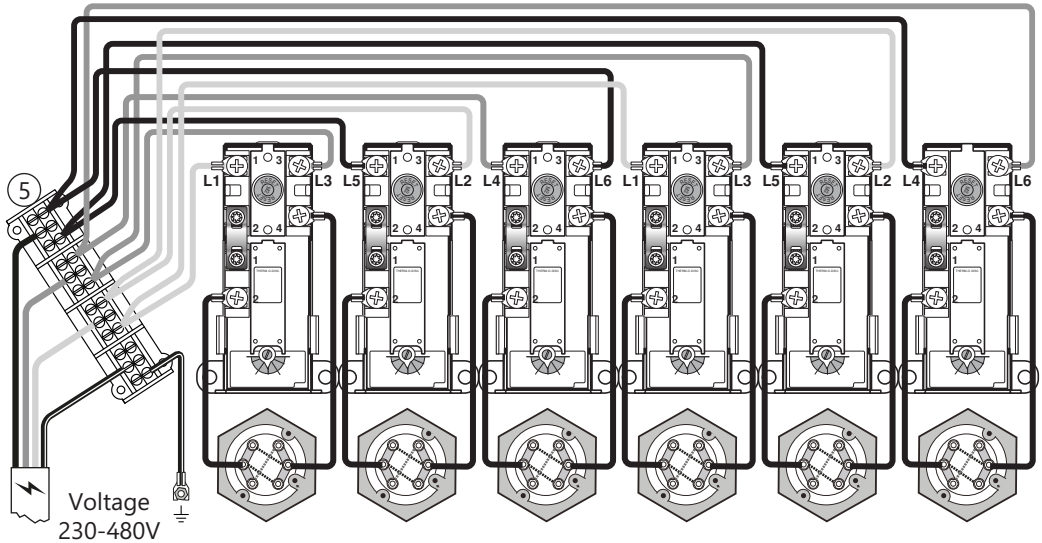



4.7.3 Torque settings - std. junction box



Component	Torque
G 1.1/4" - 1.1/2" heating element	60 Nm (+/- 5)
Thermostat screws	2 Nm (+/- 0.1)
Screw on the element head	2 Nm (+/- 0.1)

4.7.4 Fitting instructions

WARNING

	The product must be filled with water before the power is switched on.
	Fixed electrical fittings must be used for installation according to the regulations. Any electric fittings must be installed by an authorised electrician.
	The mains cable shall withstand 90°C. A suitable strain reliever must be fitted.

CAUTION

	The product must have a clearance for servicing of 40 cm in front of the junction box cover.
	In case of damage to the power supply cable it shall be replaced with new cable with the correct specifications for the installation. All electrical work should be performed by an authorised electrician.

RECOMMENDATION

-	An authorised electrician shall calculate the correct supply cable and fuse according to the applicable standards and regulations.
---	--

4.8 K12 terminal box - optional

The K12 terminal boxes (1) is approved for installation in boilers designed for heating of water. It is possible to fit multiple K12 elements in one boiler, each with a separate power supply.

Effect 230 / 690V - Max. 3x20A - voltage depending on element type.

The electric terminal box is fitted with a 5-pole terminal block 4 mm², a 3-pole temperature limiter (t2) 102°C with manual reset and a 1-pole thermostat (t1) 30-90°C.

A bag containing 2 fastener screws for the box is supplied inside the terminal box, along with a steel rail for the thermostat pocket in the heating element, along with jumpers and connection materials for electric connection of the heating element.

Important:

If the power cable to the K12 terminal box is fitted where the surrounding temperature exceeds +75°C a power cable approved for the surrounding temperature range must be fitted. The surrounding temperature of the K12 terminal box **MUST NOT** exceed 50°C.

The K12 terminal box shall not be exposed to excessive heat radiation, such as near a boiler or furnace for solid fuels with a door where bare flames can appear when stoking.

Disclaimer:

1. The K12 terminal box must be fitted by an authorised electrician.
2. Electrical connection must be performed in accordance with the wiring diagram supplied inside the electric terminal box as well as current laws and regulations.
3. The K12 terminal box power supply must be fed through an all-pole switch which is to be installed in the power supply circuit.

Wiring diagram schematics, see pt. 4.7.5.

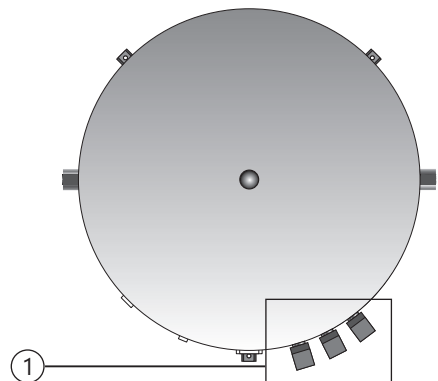
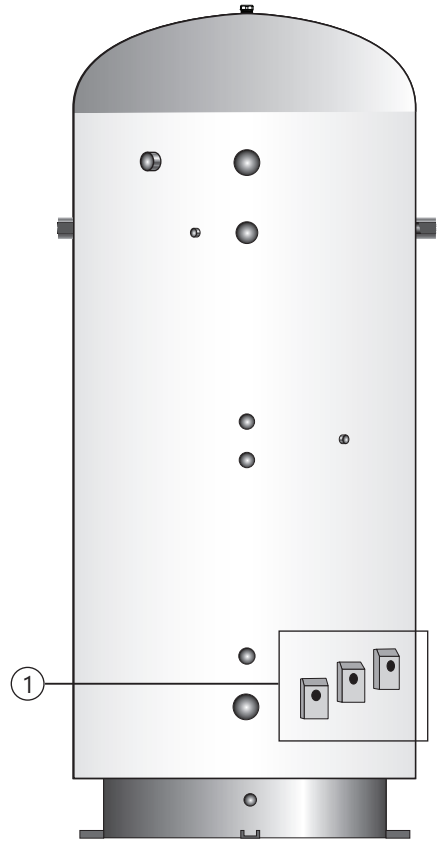

4.8.1 Wiring diagrams - K12 terminal box
 Effect 230 / 690V - Max. 3x20A - voltage depending on element type.

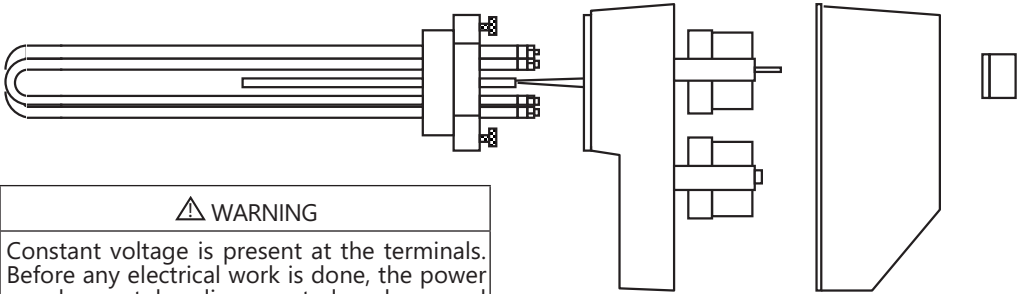

⚠ WARNING

Constant voltage is present at the terminals. Before any electrical work is done, the power supply must be disconnected and secured against activation while the work is in progress.

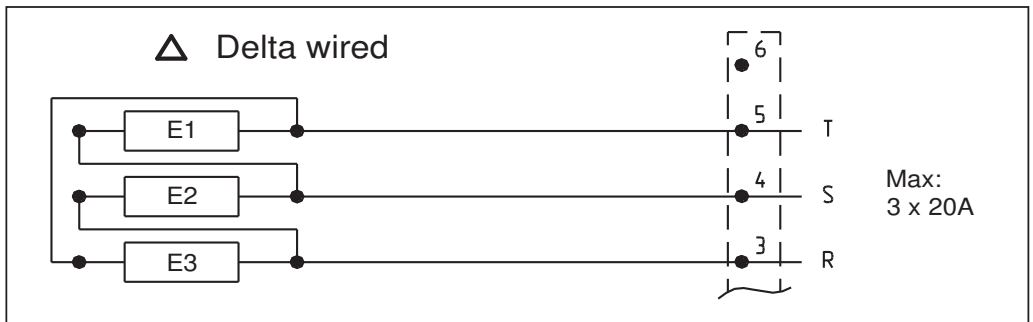
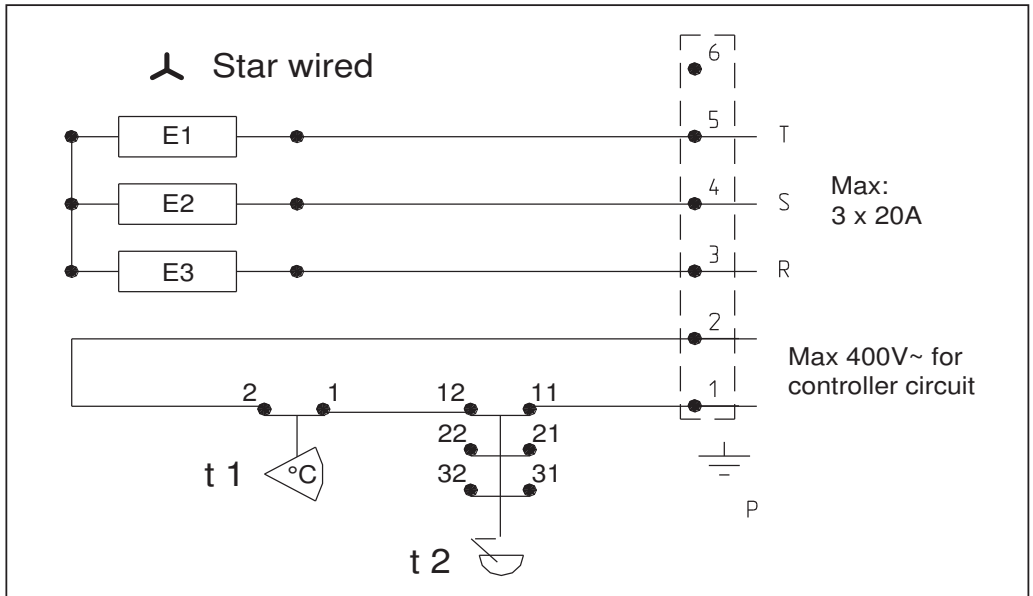

5. INITIAL COMMISSIONING

5.1 Filling with water

First check that all pipes are connected correctly. Then fill the tank according to the needs/requirements of the system. Make sure that the tank is vented during filling to prevent air pockets.

5.2 Turning on the power

When the cylinder has been filled with water, the power can be switched on (if fitted):

A) Switch on breaker/fuse.

5.3 Control points

A) Check that all pipe connections to/from the product are tight and not leaking.

B) Check that the power supply to the product (if fitted) is not at risk of exposure to mechanical, thermal or chemical damage.

C) Check that any overflow pipe from the safety valve is clear, undamaged and frost-free with a fall to the drain.

D) Check that the product is standing firmly vertically and horizontally.

5.4 Emptying of water

 WARNING
--

The water temperature in the product is 75°C and could cause scalding. Before emptying, a hot tap shall be opened to the max. pressure/temperature for min. 3 minutes.
--

A) Disconnect the power supply (if fitted).

B) Shut off incoming cold water supply.

C) Open a hot tap to the maximum
– leave open (prevents vacuum).

D) The product is emptied using the drain (1).

After emptying, close the drain (1). Close all open taps.

5.5 Handover to end-user

THE INSTALLER MUST:

Brief the end-user on safety and maintenance instructions.
--

Brief the end-user on settings and emptying the product.
--

Hand this installation manual over to the end-user.

Enter contact details on the type plate on the product.

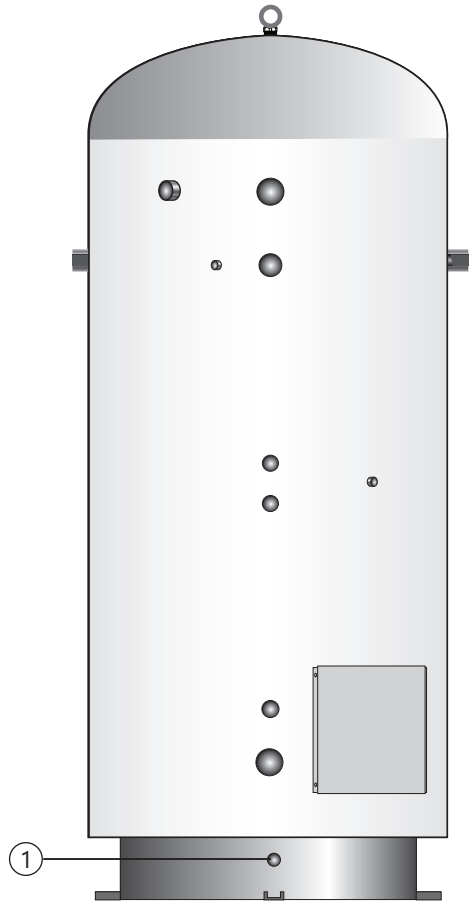

6. USER GUIDE

6.1 Settings

6.1.1 Thermostat setting (not K12 terminal box)

The thermostats are adjustable from 40-70°C or 60-90°C depending on spec. The thermostat should not be set lower than 65°C to prevent bacteria growth. To adjust the temperature:

- A) Disconnect the power supply.
- B) Remove the cover (2) with a screwdriver.
- C) Adjust the temperature on the thermostats (3) with a screwdriver.

Fit the cover (2) before connecting the power supply.

6.1.2 Resetting the safety thermostat

The safety thermostats on the product cut out when there is a risk of overheating. These are reset by switching off the power supply, removing the cover (2) and pressing the red 'RESET' button (4). If the thermostat cuts out repeatedly, contact the installer.

6.2 Annual inspection

All components fitted in or to the product must be inspected annually. Inspection must be performed by person older than 18 years of age, with appropriate qualifications. Annual inspection includes:

- Checking all connections for leaks. Tighten or maintain properly if required..
- Tighten all connections in the electric junction box:
 - A) Disconnect power supply and ensure against activation while work is in progress.
 - B) Remove junction box cover (2) and tighten all connections to the correct torque as shown in table 4.6.3. The junction box cover must be refitted before power is

turned back on.

- Inspection of safety valve operation, see pt. 5.3.

⚠ WARNING

Constant voltage is present in the junction box. Before any electrical work is done, the power supply must be disconnected and secured against activation while the work is in progress.

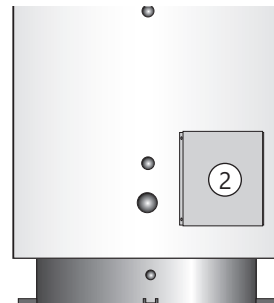
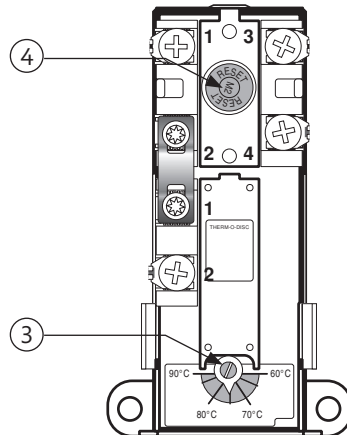

6.3 Maintenance

MAINTENANCE INSTRUCTIONS

⚠	Maintenance should be carried out by persons over 18 years of age, with sufficient understanding.
⚠	Annual inspection of safety valve:
-	Open valve for 1 min. by turning the knob (1) counterclockwise to the open position.
-	Visually check that the water is flowing freely to the drain.
-	YES = OK. Close the valve by turning knob (1) further clockwise until valve shuts.
-	NO = NOT OK. Disconnect power supply / shut off water supply. Contact installer.

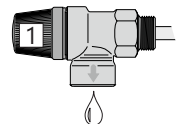

7. WARRANTY CONDITIONS

1. Scope

OSO Hotwater AS (hereinafter called OSO) warrants for 2 years from the date of purchase, that the Product will: i) conform to OSO specification, ii) be free from defects in materials and workmanship, subject to conditions below. All components carry a 2-year warranty.

The warranty is voluntarily extended by OSO to 5 years for the stainless steel inner tank. This extended warranty only applies to Products purchased by a consumer, that has been installed for private use and that has been distributed by OSO or by a distributor where the Products have been originally sold by OSO. The extended warranty does not apply to Products purchased by commercial entities or for Products that have been installed for commercial use. These shall be subject only to the mandatory provisions of the law. The conditions and limitations set out below shall apply.

2. Coverage

If a defect arises and a valid claim is received within the statutory warranty period, at its option and to the extent permitted by law, OSO shall either: i) repair the defect, or; ii) replace the product with a product that is identical or similar in function, or; iii) refund the purchase price.

If a defect arises and a valid claim is received after the statutory warranty period has expired, but within the extended warranty period, OSO will supply a product that is identical or similar in function. OSO will in such cases not cover any other associated costs.

Any exchanged Product or component will become the legal property of OSO. Any valid claim or service does not extend the original warranty. The replacement Product or part does not carry a new warranty.

3. Conditions

The Product is manufactured to suit most public water supplies. However, there are certain water chemistries (outlined below) that can have a detrimental effect on the Product and its life expectancy. If there are uncertainties regarding water quality, the local water supply authority can supply the necessary data.

The warranty applies only if the conditions set out below are met in full:

- The Product has been installed by a professional installer, in accordance with the instructions in the installation manual and all relevant Codes of Practice and Regulations in force at the time of installation.
- The Product has not been modified in any way, tampered with or subjected to misuse and no factory fitted parts have been removed for unauthorized repair or replacement.
- The Product has only been connected to a domestic mains water supply in compliance with the European Drinking Water Directive EN 98/83 EC, or latest version. The water

should not be aggressive, i.e. the water chemistry shall comply with the following:

- Chloride	< 250 mg / L
- Electric Conductivity (EC) @25°C	< 750 uS / cm
- Saturation Index (LSI) @80°C	> - 1,0 / < 0,8
- pH level	> 6,0 / < 9,5

- The immersion heater has not been exposed to hardness levels exceeding 10°dH (180 ppm CaCO3). A water softener is recommended in such cases.
- Any disinfection has been carried out without affecting the Product in any way whatsoever. The Product shall be isolated from any system chlorination.
- The Product has been in regular use from the date of installation. If the Product is not intended to be used for 60 days or more, it must be drained.
- Service and/or repair shall be done according to the installation manual and all relevant codes of practice. Any replacement parts used shall be original OSO spare parts.
- Any third-party costs associated with any claim has been authorized in advance by OSO in writing.
- The purchase invoice and/or installation invoice, a water sample as well as the defective product is made available to OSO upon request.

Failure to follow these instructions and conditions may result in product failure, and water escaping from the Product.

4. Limitations

The warranty does not cover:

- Any fault or costs arising from incorrect installation, incorrect application, lack of regular maintenance in accordance with the installation manual, neglect, accidental or malicious damage, misuse, any alteration, tampering or repair carried out by a non-professional, any fault arising from the tampering with or removal of any factory fitted safety components or measures.
- Any consequential damage or any indirect loss caused by any failure or malfunction of the Product whatsoever.
- Any pipework or any equipment connected to the Product.
- The effects of frost, lightning, voltage variation, lack of water, dry boiling, excess pressure or chlorination procedures.
- The effects of stagnant (de-aerated) water if the Product has been left unused for more than 60 days consecutively.
- Damage caused during transportation. Buyer shall give the carrier notice of such damage.
- Costs arising if the Product is not immediately accessible for servicing.

These warranties do not affect the Buyer's statutory rights.

- A) The installer who supplied the product.
- B) OSO Hotwater AS: Tel.: +47 32 25 00 00
oso@oso.no / www.oso.no

7.1 Customer service

In case of problems that cannot be resolved with the aid of the troubleshooting guide in this installation manual, contact either:

8. REMOVING THE PRODUCT

8.1 Removal

- A) Disconnect the power supply.
- B) Shut off incoming cold water supply.
- C) Empty the product of water – see section 4.4.
- D) Disconnect all pipes.
- E) The product can now be removed.

8.2 Returns scheme

This product is recyclable and should be taken to the environmental recycling centre. If the product is to be replaced with a new one, the installer can take the old cylinder away for recycling.

OSO

HOTWATER

OSO Hotwater AS

Industriveien 1
3300 Hokksund - Norway
Tel: + 47 32 25 00 00
oso@oso.no
www.osohotwater.com